

OPERATING MANUAL

Versa HomeTravel Series | Air+Surface Sterilizer

CONTENTS



SAFETY PRECAUTIONS	1
DEVICE IDENTIFICATION	3
GETTING STARTED	7
OPERATION	9
SAFETY FEATURE	10
MAINTENANCE & SERVICE	11
TROUBLESHOOTING GUIDE	16
SPECIFICATIONS	18

Congratulations on your purchase of the **MedKlinn Versa Air+Surface Sterilizer**! It incorporates the most innovative and latest air+surface cleaning technology, the Cerafusion™ Technology. Please read the following instructions carefully before using the unit. With a little care, it will help you create a clean, fresh and healthy living space for many years.

 WARNINGS - TO REDUCE THE RISK OF ELECTRICAL SHOCK, FIRE OR INJURY:

1. Do not use the unit if the power cable or plug is damaged.
2. Do not insert any sharp or pointed object through the ventilation holes of the unit.
3. Do not let children play with the unit.
4. Do not immerse the unit in water, or allow water or any fluids to enter through the ventilation holes.
5. When removing the power plug, always hold the plug and never pull the cable.
6. Do not remove the power plug when your hands are wet.
7. Remove the power plug from the wall socket before cleaning the unit.
8. Do not modify, disassemble or repair this unit by yourself.
9. Do not replace the electric plug or cut the power cable. Replacing the plug or cutting the power cable in any way will immediately cause the Warranty to become void. Any subsequent fault in the operation of the unit will not be covered by the Warranty, and repair and servicing will be chargeable.
- 10.If the power cable is damaged, it must be sent to an authorized Medkinn Service Centre for repair.
- 11.Do not attempt to open the unit. The unit requires minimal maintenance, and no servicing or repairs are to be carried out by the User. Opening the device or tampering with it in any way will cause the Warranty to become void. If you encounter any problems with the unit, please read the Troubleshooting Guide first, and if the problem persists, please contact the nearest authorized Medklinn Service Centre.
- 12.Do not wipe the unit with benzene or paint thinner.

**READ AND SAVE THESE INSTRUCTIONS.
FOR FURTHER ASSISTANCE, PLEASE CALL OUR CUSTOMER SERVICE.**



NOTE - RADIO OR TV INTERFERENCE:

If the unit should cause interference to radio or television reception, try to correct the interference by one or more of the following measures:

- Reorient or relocate the receiving antenna.
- Increase the distance between the unit and radio/TV receiver.
- Connect the equipment into an outlet on a circuit different from that to which the receiver is connected.
- Consult the dealer or an experienced radio/TV technician for help.



CAUTIONS DURING OPERATION

1. Place the unit at least 6 feet from radio, television or electronic equipment. This is to minimize the possibility of interference with the equipment or the remote controller.
2. Do not cover the unit in any way at all, particularly the ventilation holes. Doing so will cause excessive heat build-up and may result in a fire and irreparable damage to the unit.
3. Avoid placing the unit where curtains or other furnishings may cover the ventilation holes.
4. Avoid placing the unit in oily environments as it may cause the cartridge to be coated with a thicker layer of grease/debris. Hence, affecting its performance.
5. Ensure that there is free flow of air around the unit.
6. Avoid locations where the unit is exposed to condensation due to rapid and drastic temperature fluctuations. The unit should only be used in temperatures between 5°-35°C.
7. Effective cleaning by Active Oxygen requires adequate air exchange as they are created from oxygen. Regular air exchange will take place if the door or window is opened occasionally.
8. Do not use in small enclosed spaces where there is no or poor air circulation e.g. in wardrobes, closets or pantries.
9. Active Oxygen is very reactive, and there may be some loss of paint from poorly painted surfaces. To minimize this, do not place the unit directly against walls or other painted surfaces, and leave a space of at least one (1) foot from these surfaces.
10. It is NOT recommended to place the unit directly too close to pets.

DEVICE IDENTIFICATION

FRONT VIEW

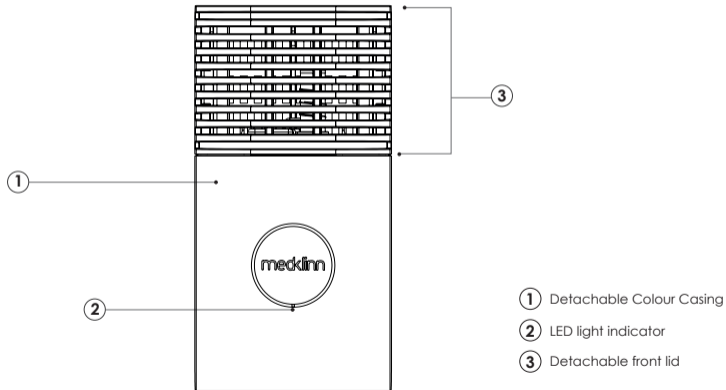

BACK VIEW

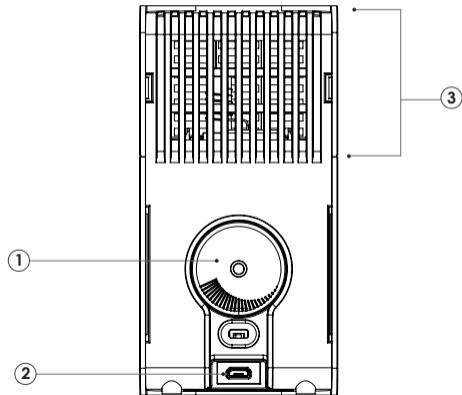

- ① Control Dial
- ② Micro USB Port
- ③ Detachable front lid

DEVICE IDENTIFICATION

- ① Power Inlet
- ② USB (B-type) Cable
- ③ USB Power Adaptor

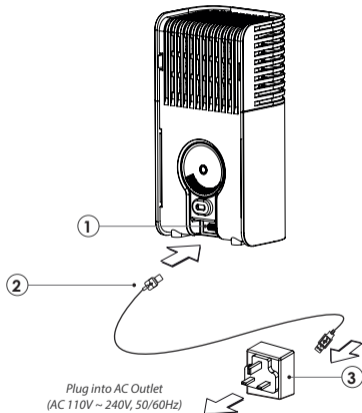

CERAFUSION™ CARTRIDGE

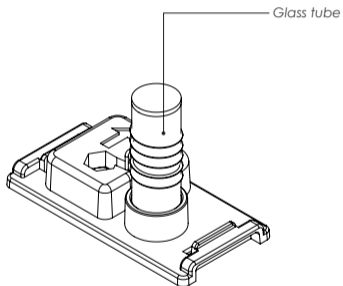

Top View

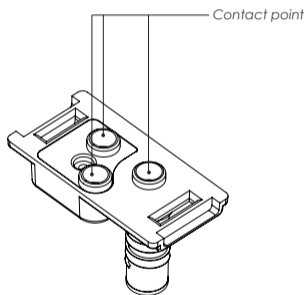

Bottom View

GETTING STARTED

2 WAYS TO TURN THE UNIT ON:

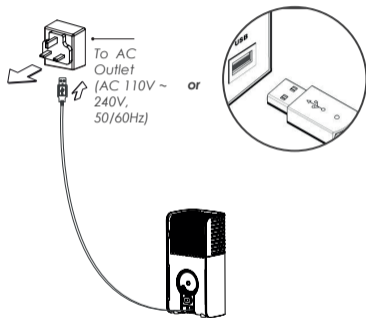

- A. USB Power Adaptor
Plug adaptor into an AC power outlet.

- B. USB power source (Minimum 5V2.4A)
- Powerbank
 - Notebook
 - Other USB power source

Important:

Power banks come with many different specifications. While some are mislabelled, the minimum specification to power the Versa is 2.4A. However, you might want to try the following if the Versa suddenly stop functioning after you have plugged on the power bank.

Step 1: Try plugging in different ports on the power bank, if available.

Step 2: Let the unit rest for at least 3 minutes and repeat Step 1 again.

Note: Ensure that the power bank is full before trying the steps above.

PLACEMENT OF UNIT:

For best performance, place the unit under a source of **air circulation such as an air conditioner or a ceiling fan**. This will enable the Active Oxygen produced by the unit to be quickly distributed throughout the room. It is highly recommended to place the unit at least 2 feet from your normal sitting or sleeping position.

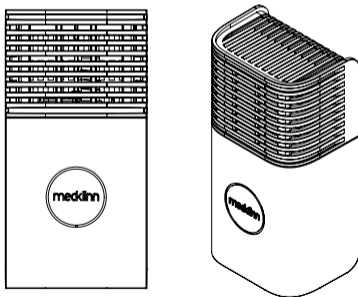

OPERATION

TO ADJUST TO LOW/HIGH SETTING:

1. To adjust to LOW mode, turn the Control Dial anti-clockwise.
2. To adjust to HIGH mode, turn the Control Dial clockwise.

TO SWITCH OFF THE DEVICE:

1. Turn the Control Dial anti-clockwise until you hear a “click” sound.

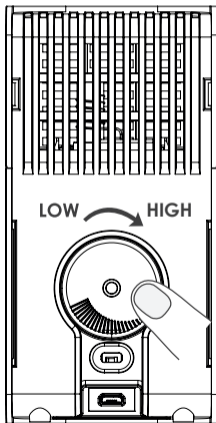

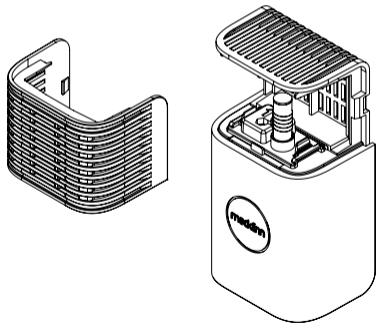

CAUTION

A safety feature is incorporated to prevent electrical shock.

In the event the front lid is detached while the unit is still operating, all LED lights will become unlit. This indicates the power to the Cerafusion™ Cartridge has been cut off.

MAINTENANCE & SERVICE

CLEANING OF DEVICE

CAUTION: SWITCH OFF AND UNPLUG THE UNIT BEFORE CLEANING

Due to water evaporation and accumulation of fine dust or other pollutants, there may be some stains around the ventilation holes.

CLEANING THE EXTERNAL PART OF DEVICE:

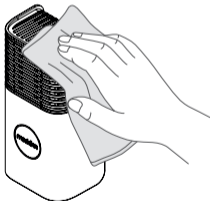

Wipe the device gently with a slightly damp cloth.

Ventilation holes

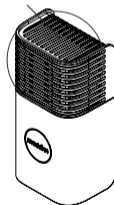

Ensure ventilation holes are not clogged with dust or dirt.

CLEANING THE INTERNAL PART OF DEVICE:

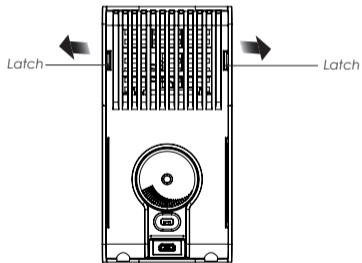

Step 1: Push the latch outward slightly to open the front lid.

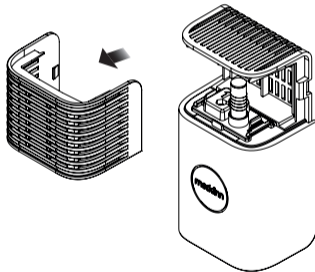

Step 2: Pull out the front lid.

MAINTENANCE & SERVICE



CAUTION:

THE CERAFUSION™ CARTRIDGE COULD BE HOT. BE CAREFUL WHEN REMOVING IT.

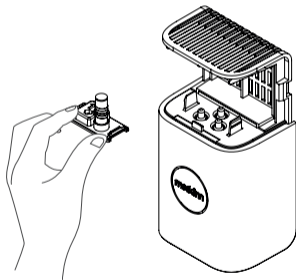

Step 3: Remove the Cerafusion™ Cartridge.

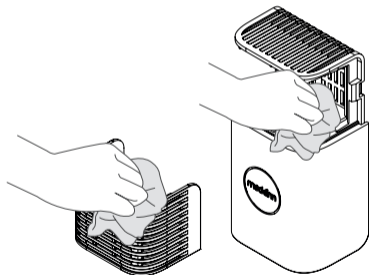

Step 4: Clean the front lid and internal surfaces with a slightly damp cloth and/or used toothbrush.

WHEN TO CHANGE CERAFUSION™ CARTRIDGE? (Recommended every 12 months)

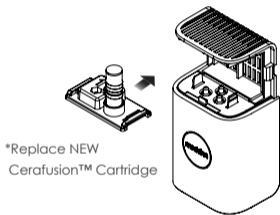

⚠ CAUTION:

1. ENSURE THAT THE UNIT IS SWITCHED OFF BEFORE REPLACING CARTRIDGE TO AVOID ELECTRICAL SHOCK.
2. DO NOT HOLD THE GLASS TUBE WHEN HANDLING THE CARTRIDGE.
3. DO NOT TURN OR TWIST THE GLASS TUBE AS IT WILL DAMAGE OR CRACK THE GLASS.

CHANGING THE VERSA CASING (OPTIONAL)

The Versa casing comes in 8 exciting colours. You can change the casing to a colour which suits your mood or decor.

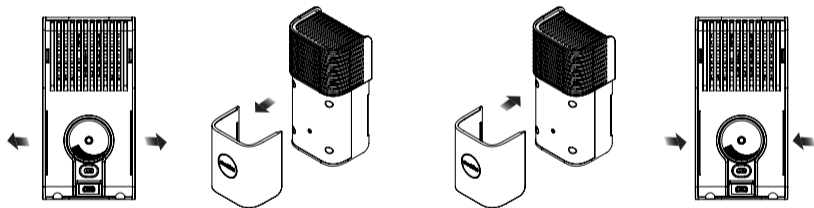

Step 1: Push the latch of the cover outward to detach it from the Versa body.

Step 2: Insert the new casing onto the Versa body until you hear a "click" sound.

1. I have switched on the unit, but the LED light is not lit and there is no hissing sound.

First, check that the power plug is properly inserted to the unit and that the power plug is connected to the power outlet and switched on. Second, make sure the front lid is properly closed. If the LED light is still unlit, contact your authorized Medklinn Service Centre to have the unit serviced.

If you are using a USB power source, please ensure the minimum output is 5V 2.4 amp.

If you are using a Powerbank, please ensure there is sufficient power remaining.

2. I have dropped the unit. Is it safe to continue using it?

First, carefully check the whole unit to make sure there are no cracks or breaks externally and internally.

Next, check the glass tube of the cartridge to make sure it is not cracked or broken.

If there is any component damage, contact your authorized Medklinn Service Centre.

3. There is a "hissing" sound coming from the unit. Is this normal?

Yes. It is normal. The "hissing" sound indicates that the Cerafusion™ Cartridge is generating Active Oxygen.

4. I have switched on the unit, the LED Indicator light is lit, but there is no "hissing" sound coming from the unit.

First, check if the Cerafusion™ Cartridge is properly inserted into the cartridge holder. If there is still no "hissing" sound after replacing a new cartridge, contact your authorized Medklinn Service Centre to have the unit serviced.

TROUBLESHOOTING GUIDE

5. The LED Indicator light is blinking every 2 second non-stop. What happened?

It means the front lid of the unit is not closed properly.

If the light remains blinking after closing the front lid properly, contact your authorized Medklinn Service Centre to have the unit serviced.

SPECIFICATIONS

MODEL	VERSA 25	VERSA 45
Input Voltage	5V2.4A	
Output Current (max)	14/12V	
Power Consumption	< 4.5 watts	
Functions	Low / Mid / High	
Dimensions (mm)	75(W) x 140(H) x 50(D)	
Operating Environment	Temperature 5° - 35°C	
Coverage Area*	Up to 250 square feet	Up to 450 square feet
Weight (unit + power adaptor)	250 grams	
Warranty	1 year limited	

* 1) Depending on the pollution level. 2) Ceiling height of 9 feet. 3) Refer to the recommended setting for different coverage area.